

ECM+ SERİSİ KOMPAKT

YÜKSEK VERİMLİLİKLİ DEĞİŞKEN HIZLI FANLAR





- + Harici EC Motor ile %70'e varan verimlilik
- + NFC Kablosuz Teknolojisi sayesinde IP sınıfına zarar vermeden hız modifikasyonu
- + Motor ve çember arasında yumuşak tamponlu bağlantı sayesinde düşük titreşim
- + Kompakt dizaynı ile dar alanlarda çalışmaya uygun
- + Çok daha büyük motor çıkış gücü

Voltaj	115VAC, 230VAC
Giriş gücü	7W-36W
Hız	800-2200 (2 Kademe)
Hız Ayarlaması	NFC (Android APP, PC)
Pervane Çapı	Ø172, Ø200, Ø230
Koruma Sınıfı	Class II
IP sınıfı	IP54
İzolasyon	Class B
Materyal	Plastik
Montaj Tipi	Tümü
Yatak	Rulmanlı
Motor Koruması	Elektronik Kartlı

BAĞLANTI DİYAGRAMI

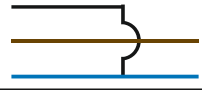
Siyah	Black	Kontrol
K.Rengi	Brown	Faz
Mavi	Blue	Nötr

BAĞLANTI DİYAGRAMI / WIRING DIAGRAM				HIZ SPEED
Siyah K.Rengi Mavi	Black Brown Blue	C L N		n1
Siyah K.Rengi Mavi	Black Brown Blue	C L N		n2
Siyah K.Rengi Mavi	Black Brown Blue	C L N		n2



Teknik Veriler

MODEL	VOLTAJ V	FREKANS Hz	AKIM A	GİRİŞ GÜCÜ W	HIZ dev/dak	HAVA AKIŞI m ³ /saat	SES SEVİYESİ dBA	ORTAM SICAKLIĞI °C
EC072/13E3G01-AS172-45P1-01	230VAC	50/60	0.08	9	1700	400	<54	-30 - +50
			0.18	21	2500	550	<63	-30 - +50
EC072/13E3G01-AS200-52P1-01	230VAC	50/60	0.05	4	900	350	<42	-30 - +50
			0.08	9	1300	540	<52	-30 - +50
			0.10	12	1500	620	<55	-30 - +50
			0.25	28	2100	900	<62	-30 - +50
EC072/13E3G01-AS230-58P1-01	230VAC	50/60	0.08	9	1000	400	<48	-30 - +50
			0.2	26	1500	960	<59	-30 - +50

PERFORMANS EĞRİLERİ

AS172

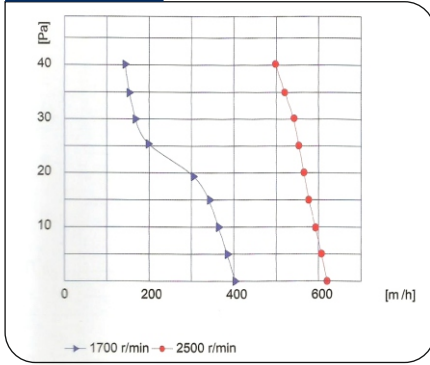

AS200

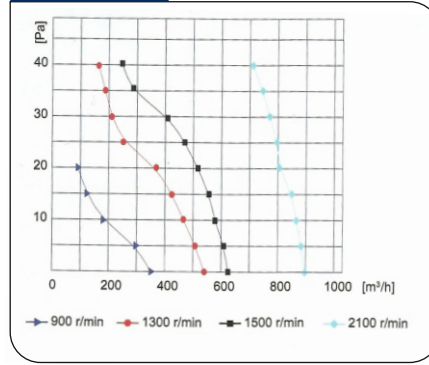

AS230

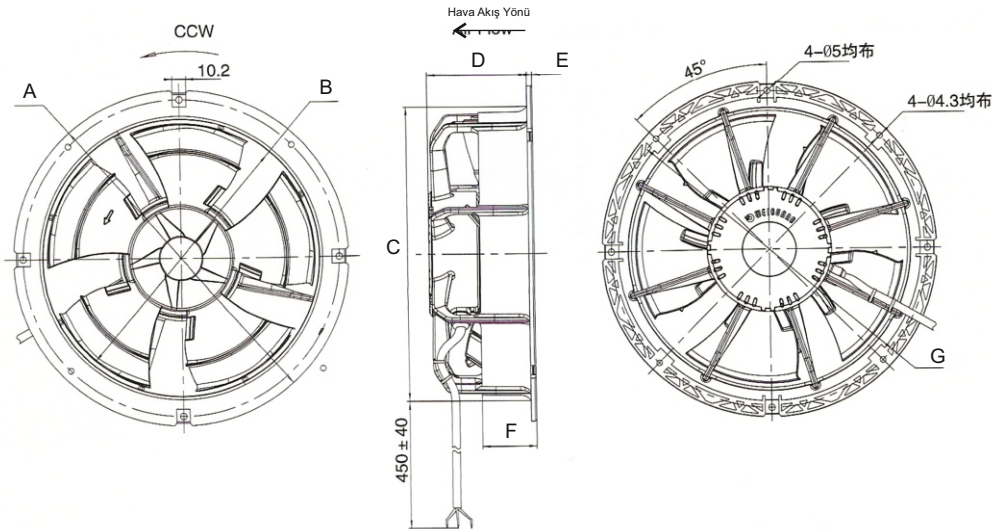
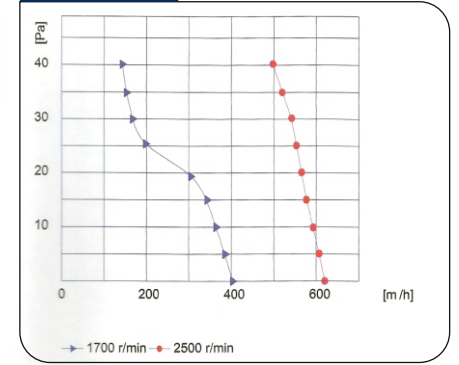

Ölçüler (mm)

MODEL	A	B	C	D	E	F	G
EC072/13E3G01-AS172-45P1-01	222	172	189	78.5±1	3.5	35	208
EC072/13E3G01-AS200-52P1-01	250	200	221	78.5±1	4	40.5	236
EC072/13E3G01-AS230-58P1-01	280	230	250	81±1	4.5	50	266